

## Canal equipado

Canales equipados

Código: 3026 880



### DETALLES

Borde Instalación      Bajo la encimera

---

Material      Acero inoxidable AISI 304

---

Acabado      Foster cepillado

---

Texture      Cepillado en la línea

---

Base      120 cm

---

Dimensiones externas      1138 x 170 mm

---

Dimensiones internas      1122 x 122 mm

---

Anchura      113,8 cm

---

Longitud      8 unidad - Standard

---

Hueco de encastre

Ver hoja de datos técnicos

---

Dotaciones estándar

Soportes de fijación, desagüe, caja de embalaje

---

Desagüe

Desagüe 1¼"

---

Clave de lectura para los accesorios.

Las longitudes de los canales y accesorios se indican en "unidades", para la composición la suma de las "unidades" de los accesorios debe corresponder a la longitud en "unidades" del canal.

---

## DIBUJOS TÉCNICOS

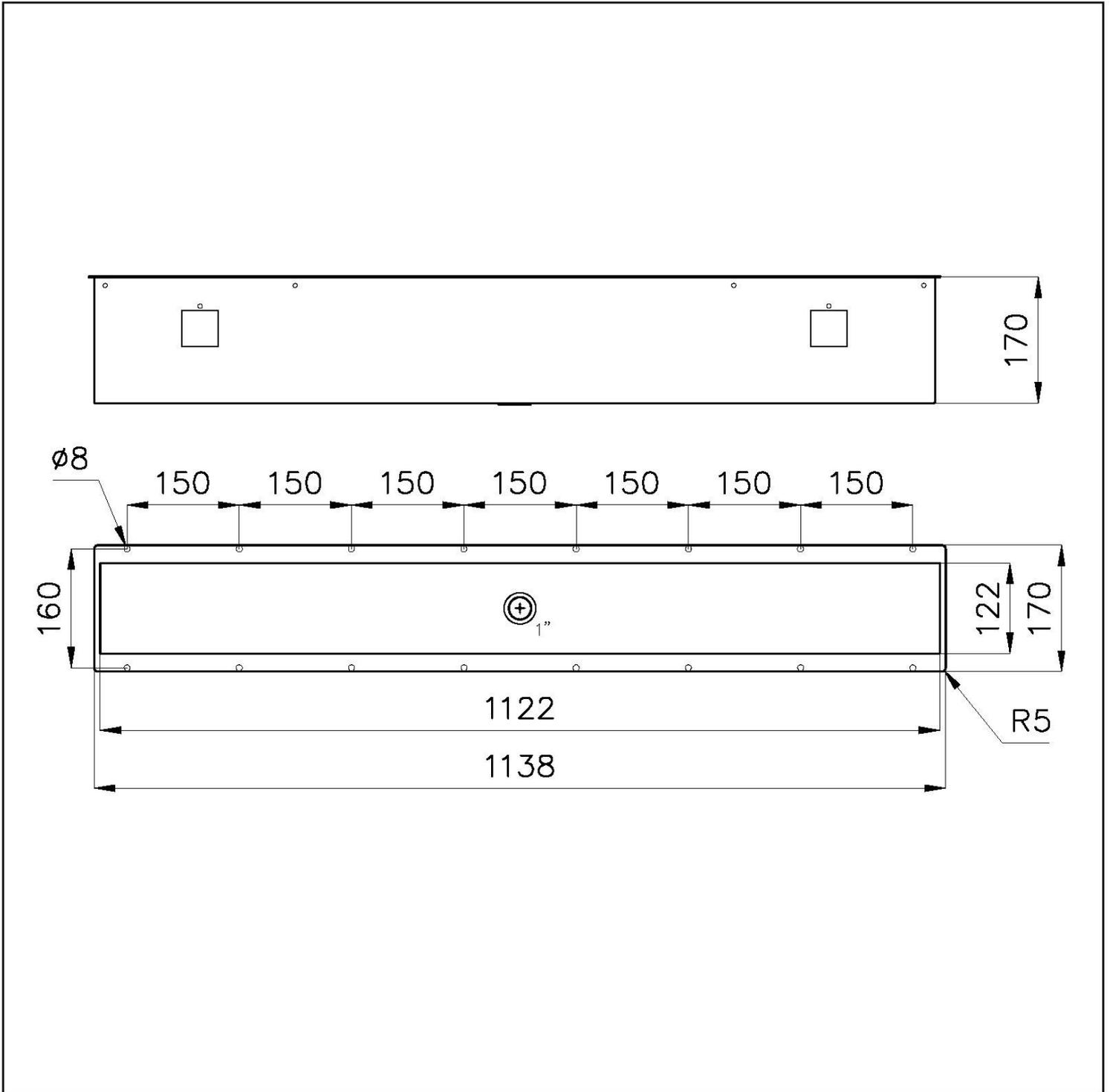

## Sottotop/Undermount

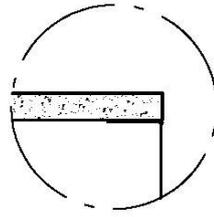

B-B:  
Dettaglio installazione  
Installation detail

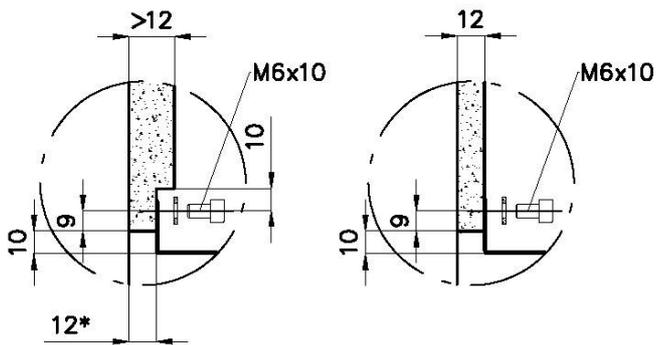

A-A:  
Dettaglio installazione positive reveal e sistema di fissaggio  
Installation detail with positive reveal and fixing system

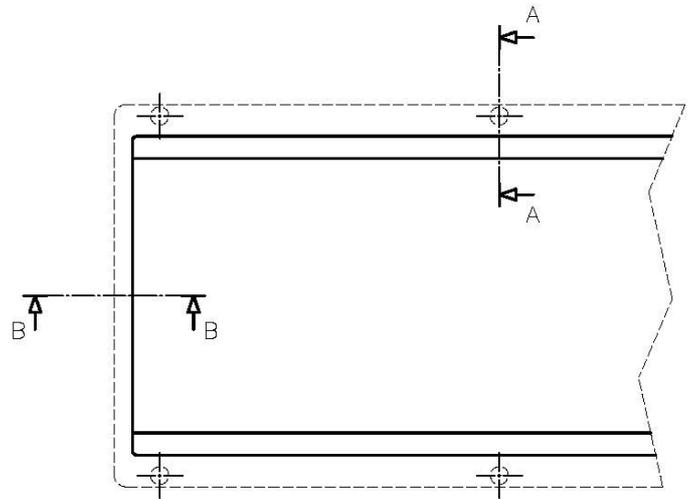

\*spessore consigliato per un abbinamento perfetto con gli accessori  
\*recommended thickness for a perfect match with the accessories

Dimensioni per foratura top  
Cut out size

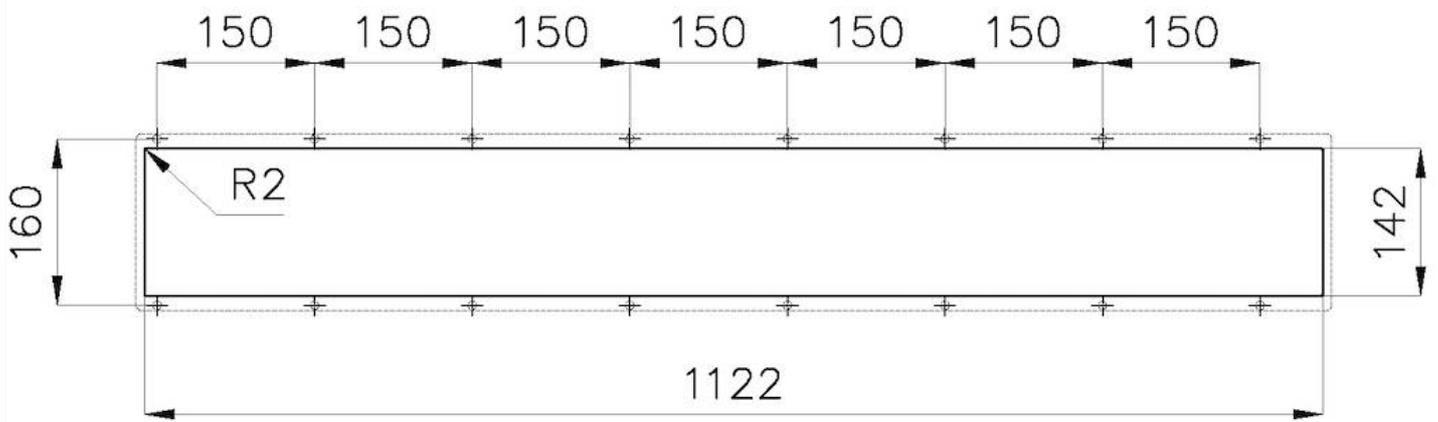

## GALERÍA



## ACCESORIOS OPCIONALES



**Bandeja perforada inox**  
8151 003



**Kit "A"**  
8100 703



**Kit "B"**  
8100 700



**Kit "C"**  
8100 701



**Kit "D"**  
8100 704



**Kit "E"**  
8100 705



**Kit "F"**  
8100 706



**Kit "G"**  
8100 710



**Kit "H"**  
8100 702



**Kit "N"**  
8100 714



**Portaplatos inox**  
1773 100



**Stainless steel knife holder**  
8100 712



**Tomas múltiples de acero  
inoxidable**  
8000 020